

THIS COPY IS PROVIDED ON A RESTRICTED BASIS AND IS NOT TO BE USED IN ANY WAY DETRIMENTAL TO THE INTERESTS OF PANDUIT CORP.

Material	High Conductivity Seamless Copper Tube
Plating	Electro-Tin
Wire Size	6 AWG
Wire Type	Stranded Copper; Class B: Compact, Compressed or Concentric, Class C: Concentric
Wire Strip Length	9/16 in.
Stud Size	3/8 in.
UL Listed Wire Connector	Yes, for applications up to 35kv. Consult cable manufacturer for voltage stress relief instructions with applications greater than 2000 volts.
UL Temperature Rating	90° C
C.S.A Certified Wire Connector	Yes
Panduit Color Code on Barrel	BLUE
Panduit Die Index No. on Barrel	P24
Alternate Industry Die Index No. () on Barrel	(7)



CERTIFIED



LISTED Wire Connector

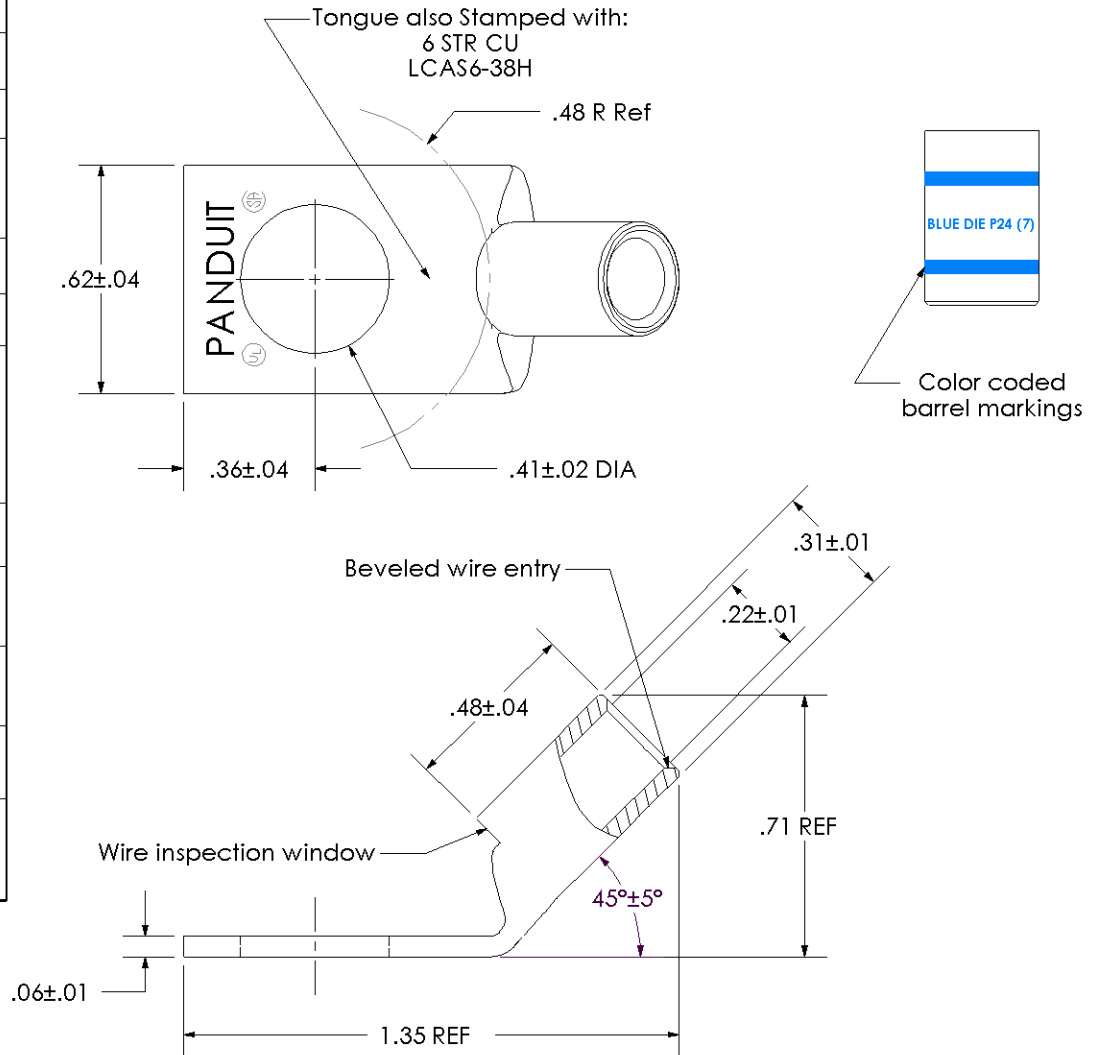

PANDUIT CORP. TINLEY PARK, ILLINOIS

LCAS6-38H-L
Copper Lug - One-Hole, Short Barrel, 45° Angle Tongue

REV	DATE	BY	CHK	DESCRIPTION	ECN
01	4-03	PWS	PWS	REMOVED PANDUIT FROM BARREL MARKINGS	10790

SCALE N/A DRAWING NO / CAD FILE LCAS6-38H-CUST